

Product Specification

Specification Number

675 A19620

Revision

01

Part No.

675 A19620

Description

Stainless Storage Drum with 1" Ferrule

Materials of Construction:

- Body: 316 stainless steel
- Ferrule: 316 stainless steel
- Lid: 316 stainless steel
- Clamp: 304 stainless steel
- Handles: 304 stainless steel
- Gasket: Silicone (FDA 177.2600 and USP Class VI compliant)

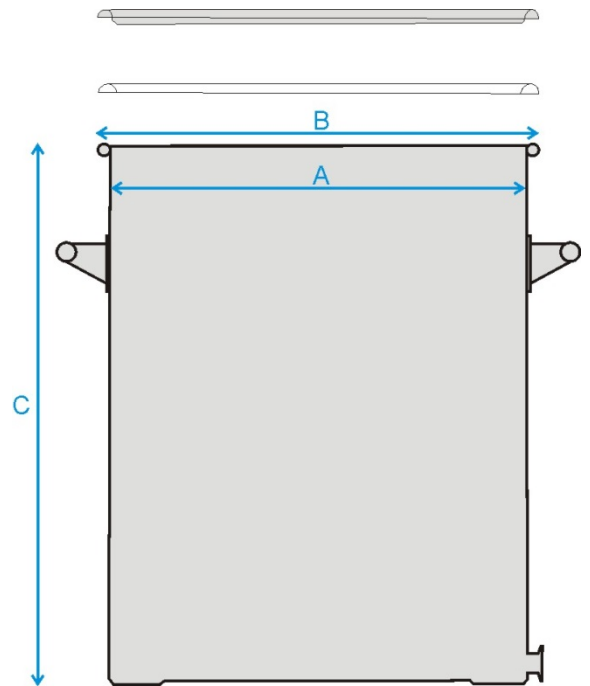

Nominal Volume:

20 Litres

Method of Construction:

Welds ground and polished

Surface Finish:

Better than 0.5 microns Ra

Dimensions

A = 300 mm
B = 320mm
C = 310 mm

Graduation Marks:

None

Handles:

2 side handles welded onto patch plates

Weight:

5.60 Kg (body + gasket + lid + clamp)